

 $[N_x]$ 

 $[N_z]$ 

 $[M_y]$ 

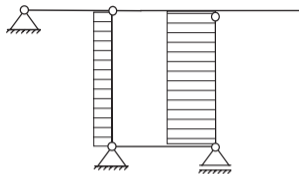

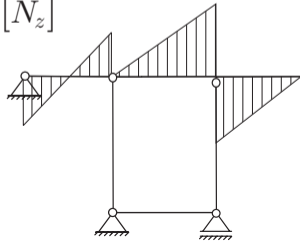
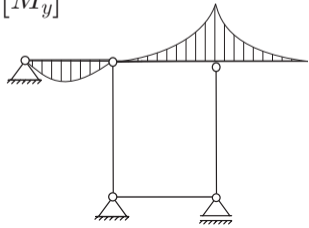
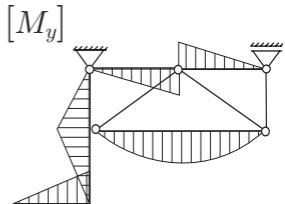
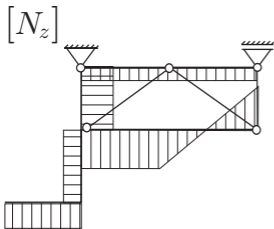
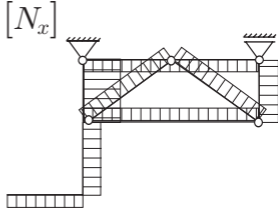
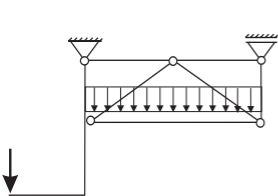
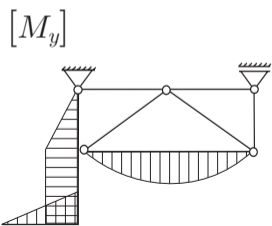
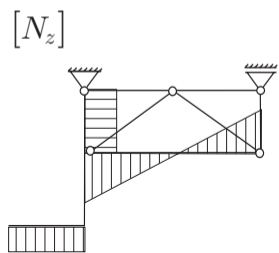
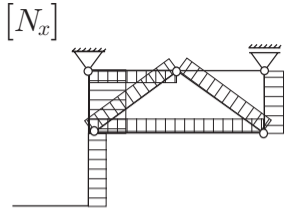
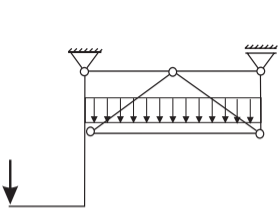
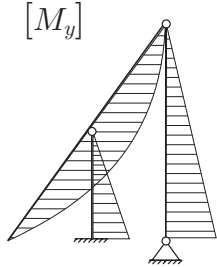
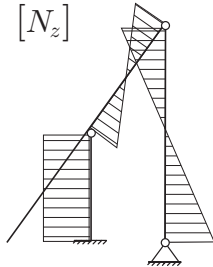
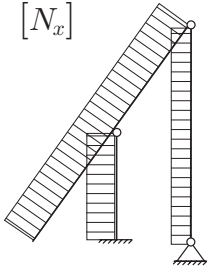
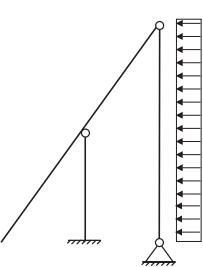
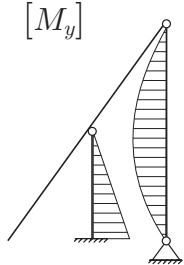
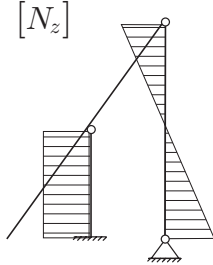
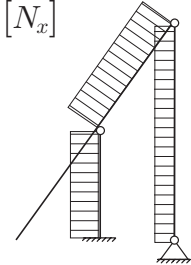
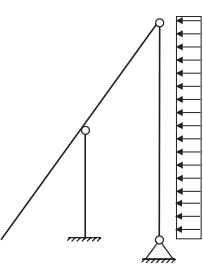
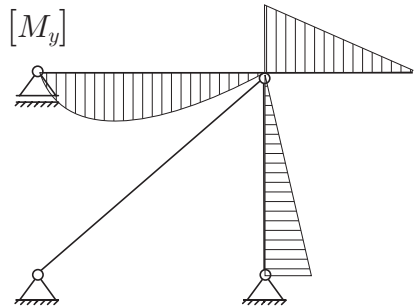
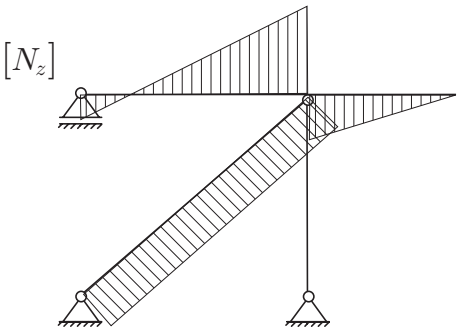
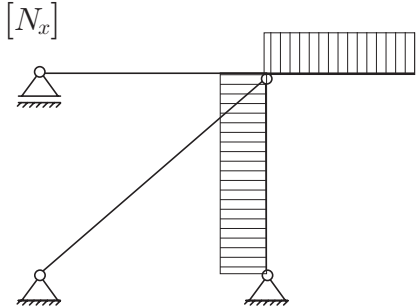
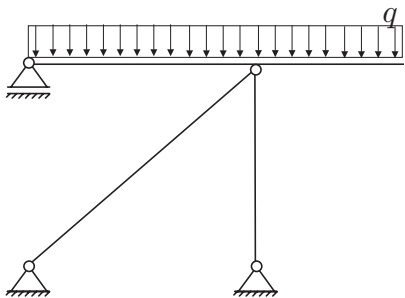







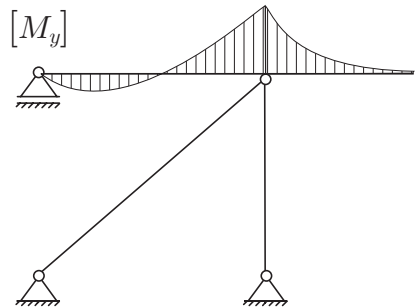
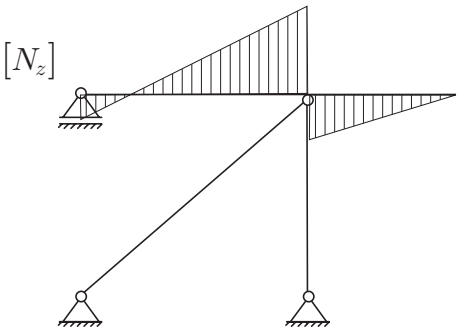
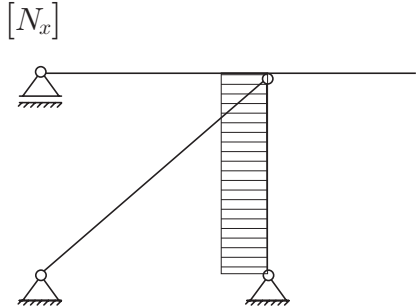
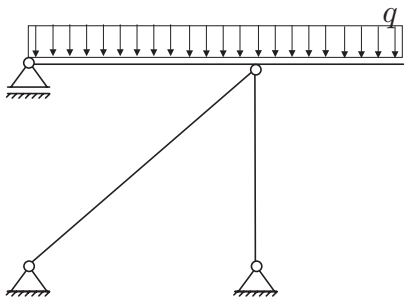



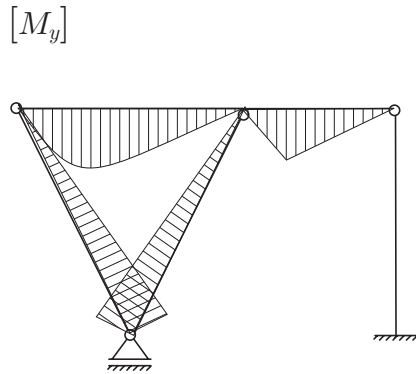
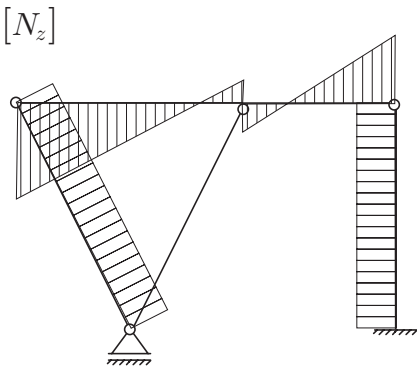
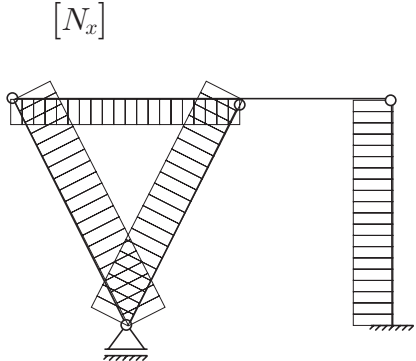
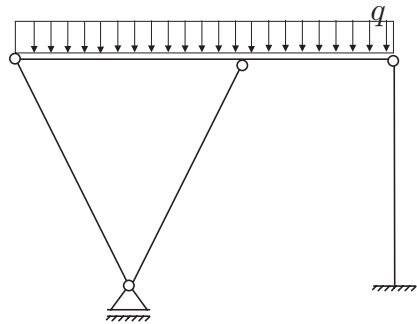

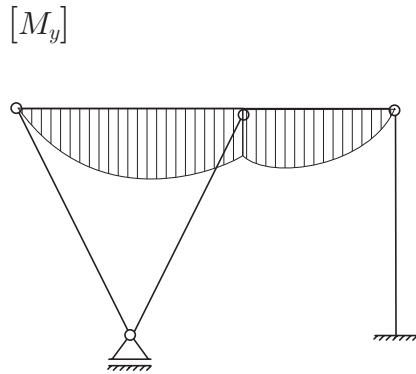
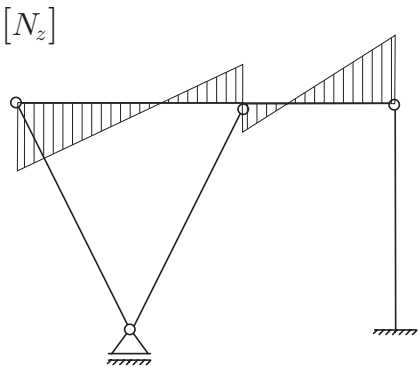
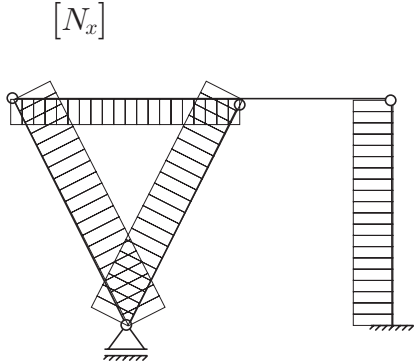
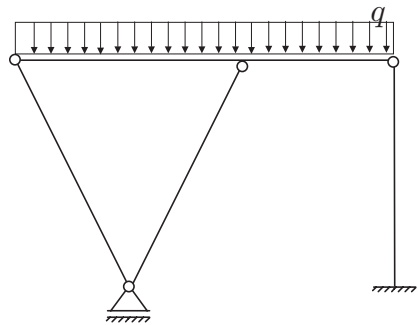

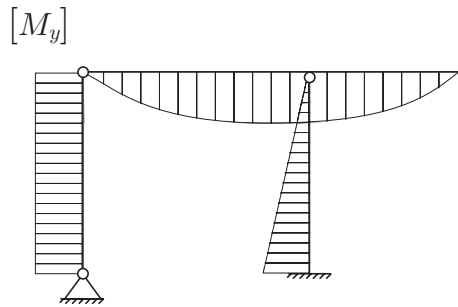
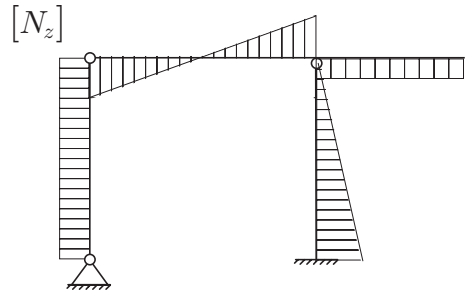
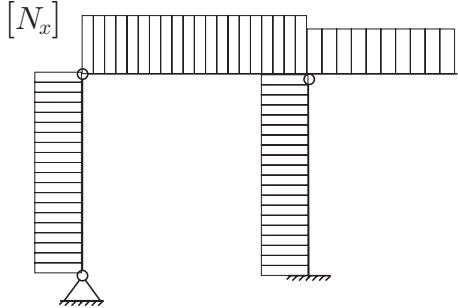
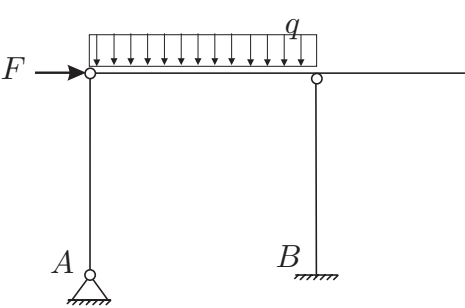

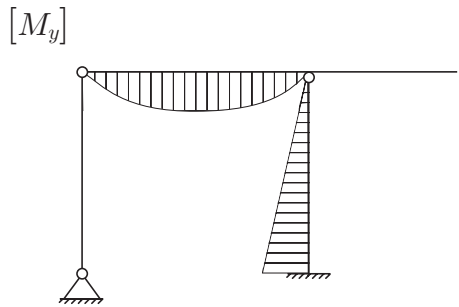
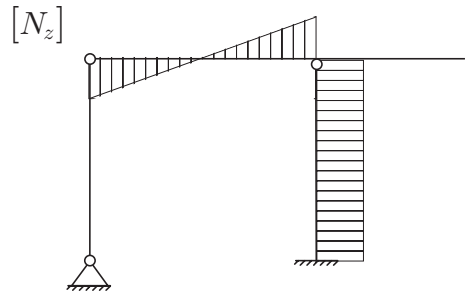
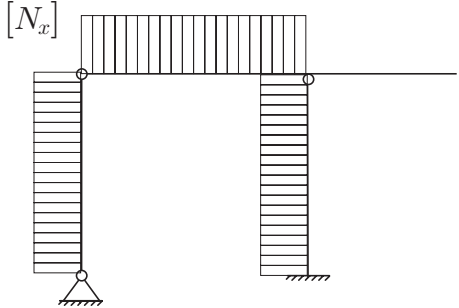
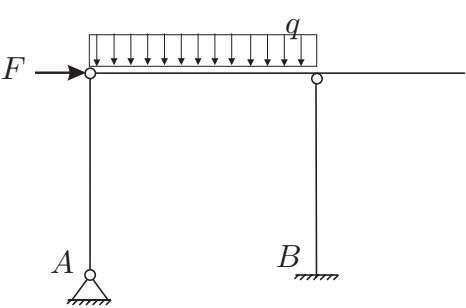

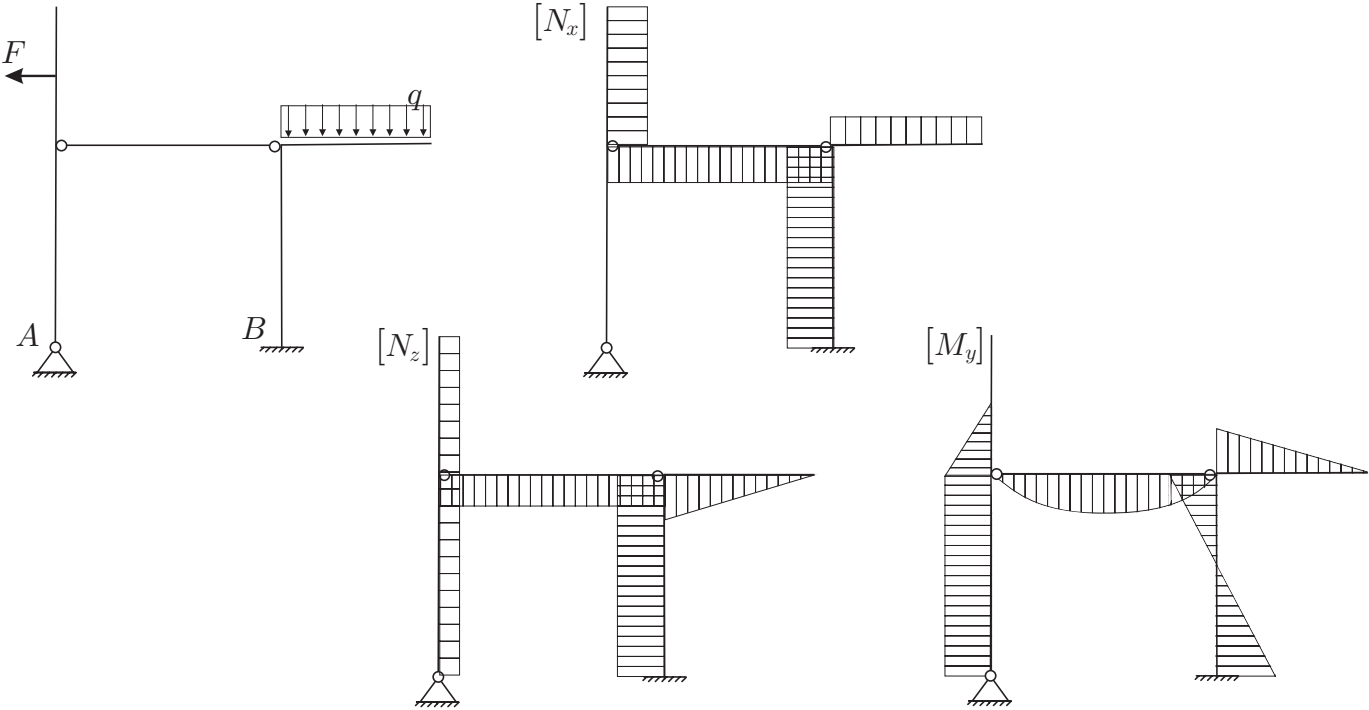

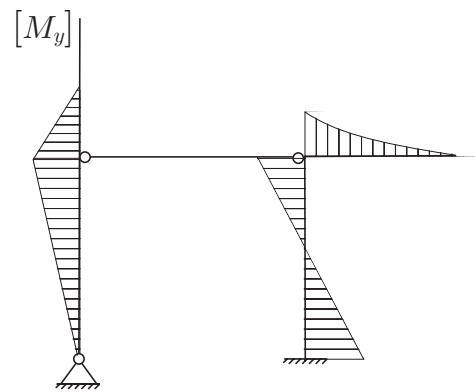
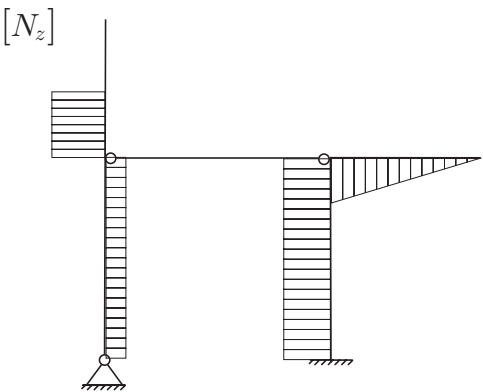
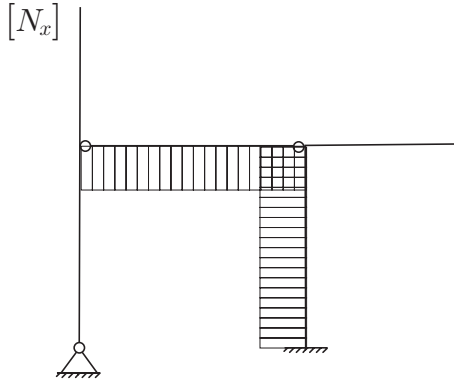
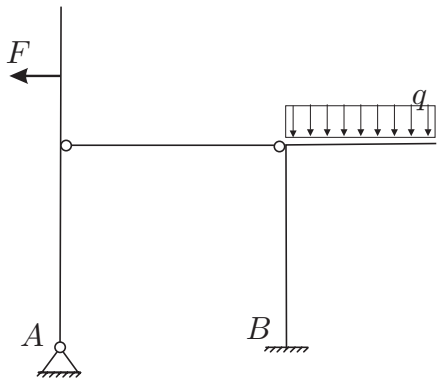

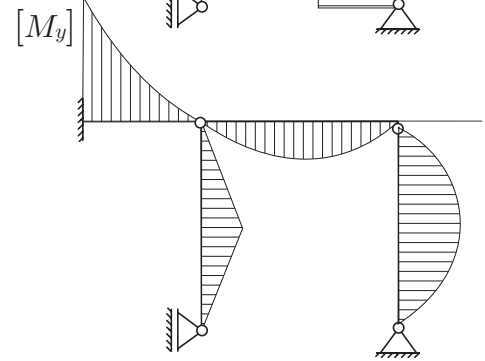
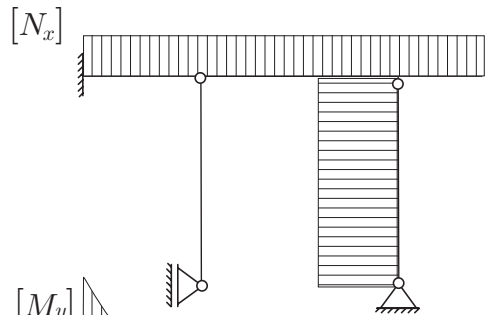
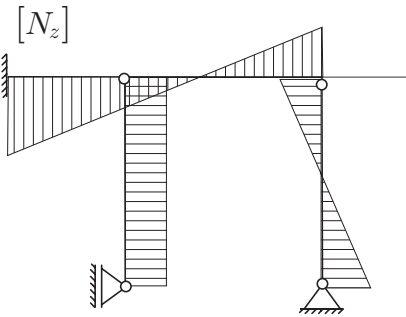
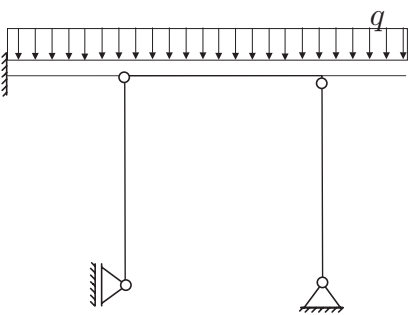

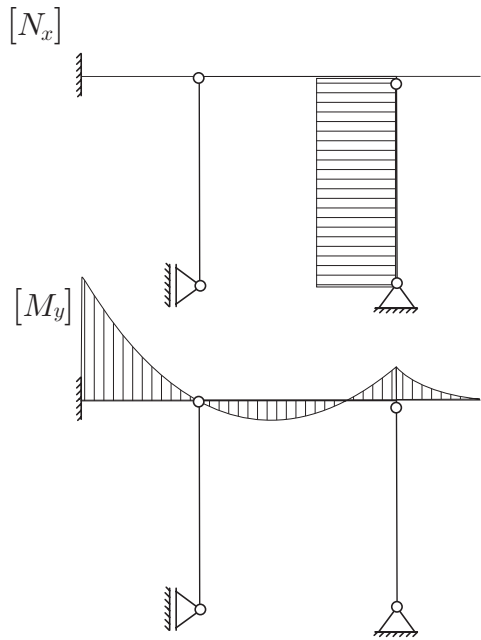
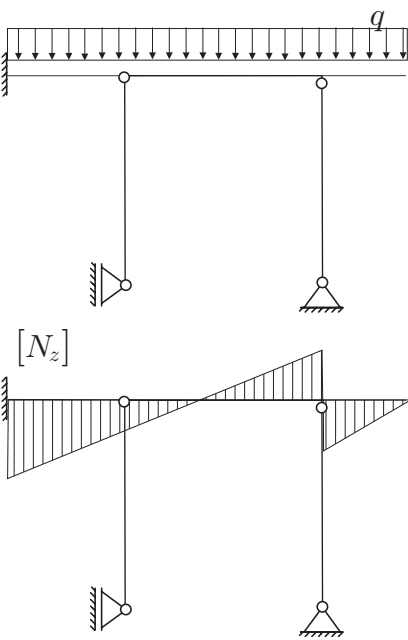



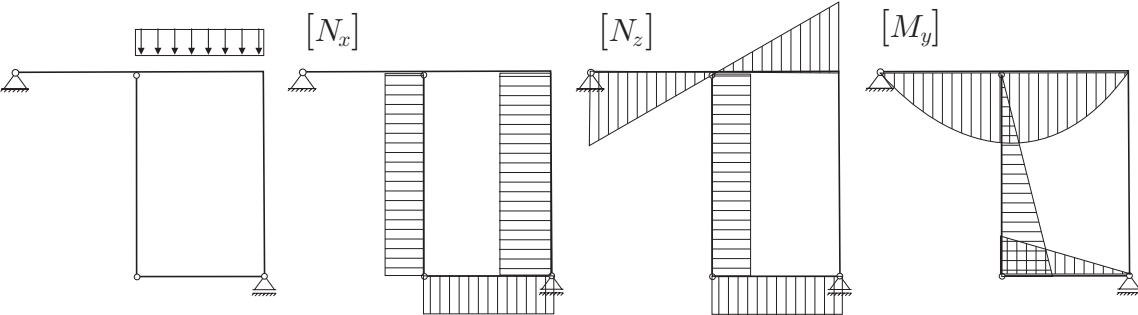

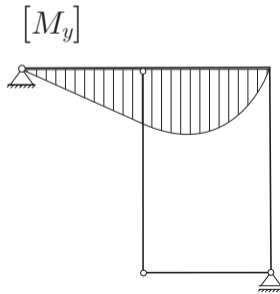
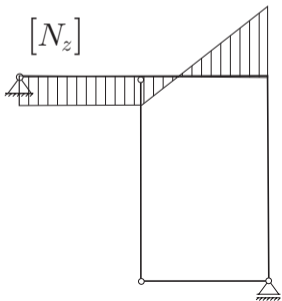
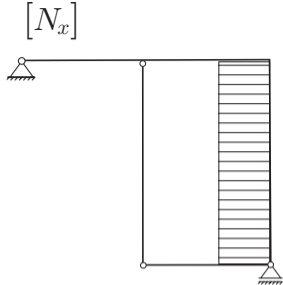
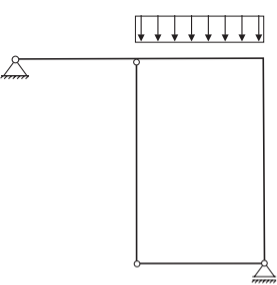

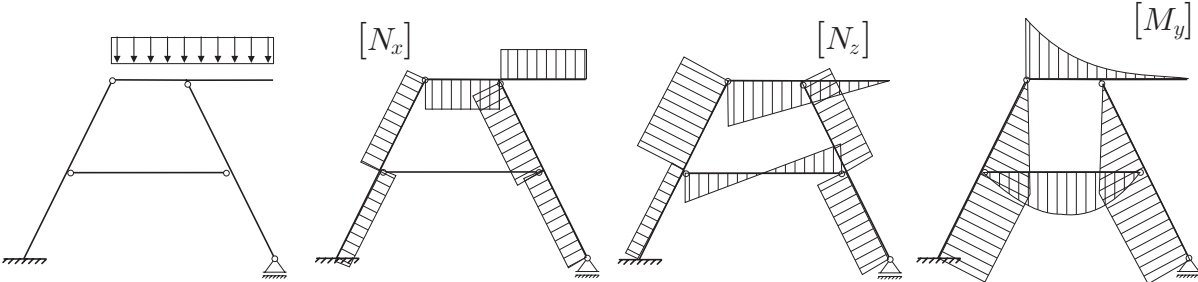

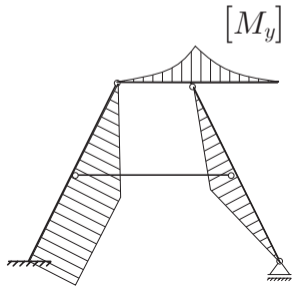
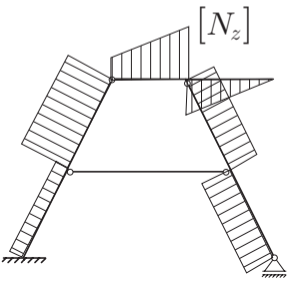
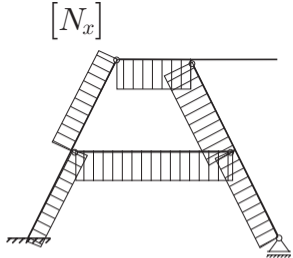
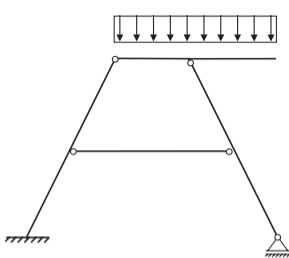

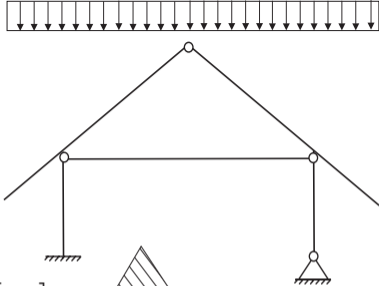
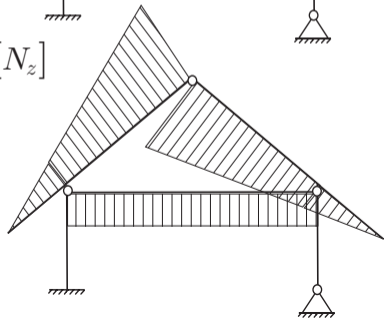
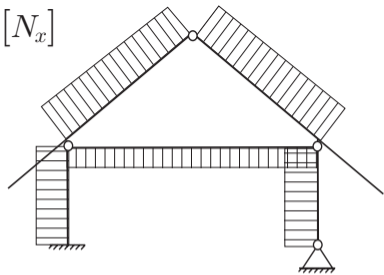
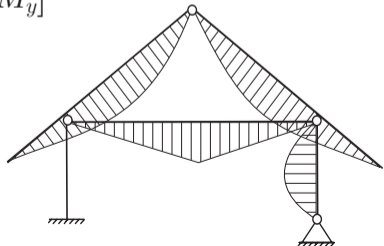

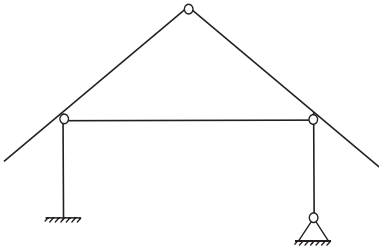
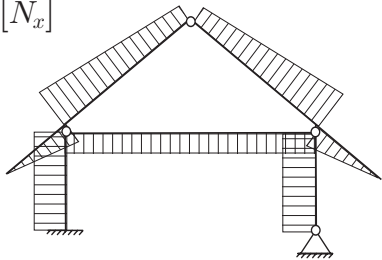
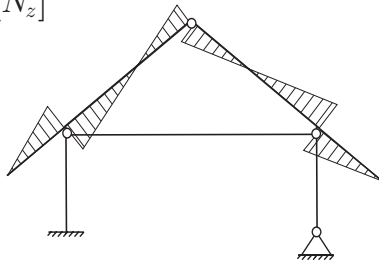
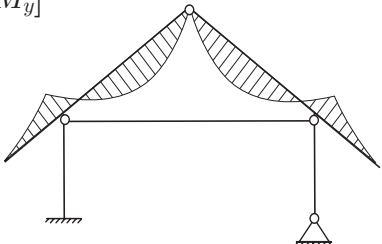
 $[N_z]$ 

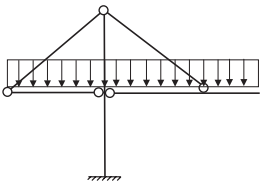
 $[N_x]$ 

 $[M_y]$ 

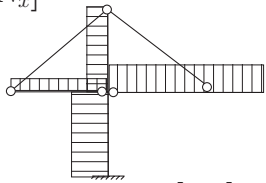
 $[N_x]$  $[N_z]$  $[M_y]$ 



$[N_x]$



$[N_z]$

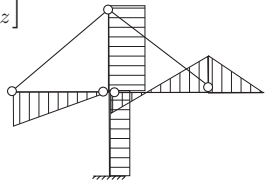

$[M_y]$

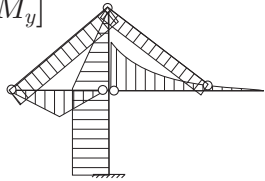

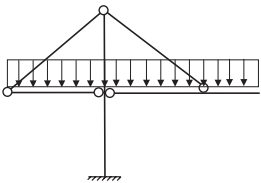

$[N_x]$

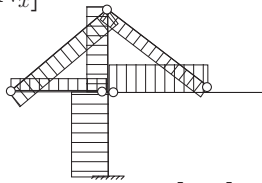

$[N_z]$

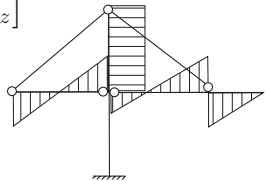

$[M_y]$

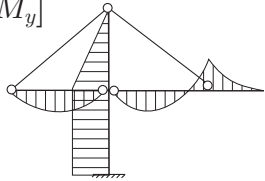



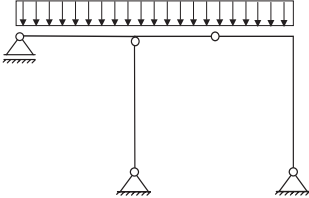
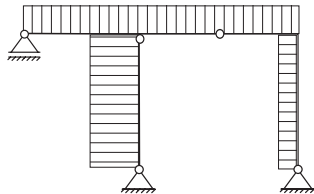
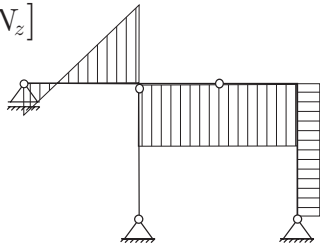
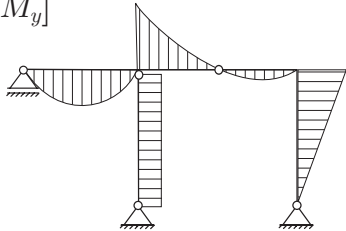

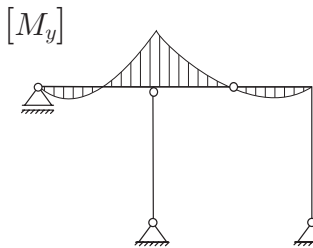
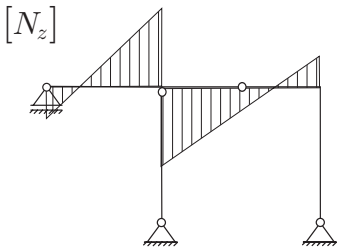
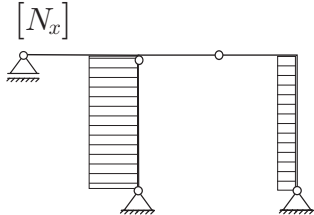
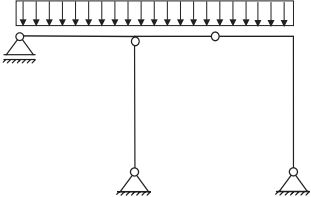
 $[N_x]$ 

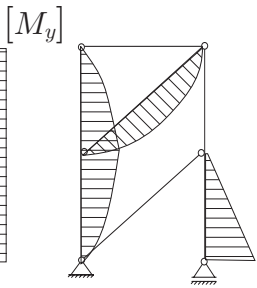
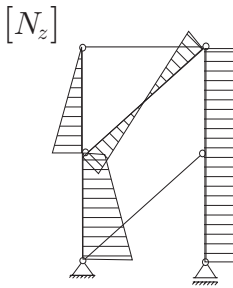
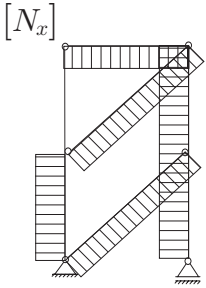
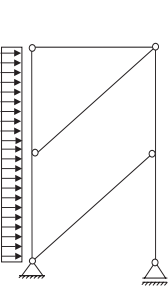
 $[N_z]$ 

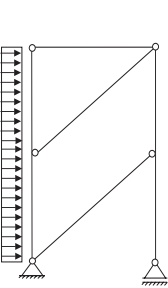
 $[M_y]$ 



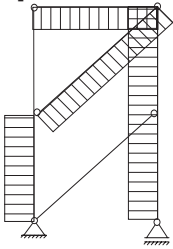



$[N_x]$



$[N_z]$

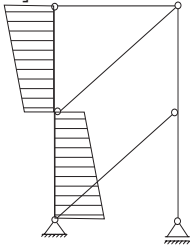

$[M_y]$

